

Circus solo

VIBIA

0176

Design By Antoni Arola

The versatile hanging Circus Solo accent spotlight allows for the definition of spaces and creation of different ambiances. The narrower angles of under 20° are perfect for generating high contrasts and distant projections.

Model Sheet

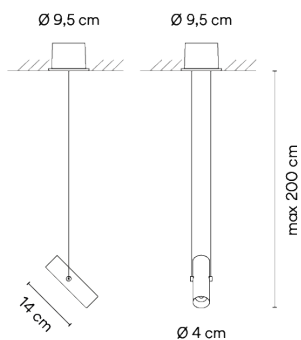
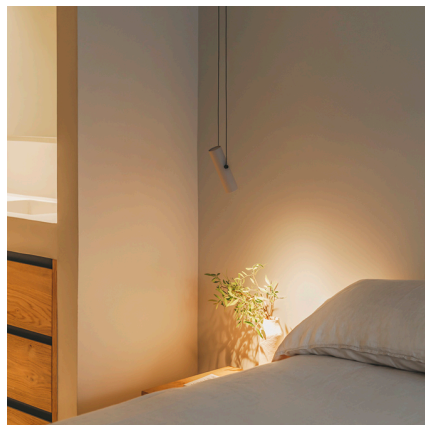

Optional: Extra cable length
Min. quantity, upcharge and extra lead time apply

Finish	 04 Black NCS S 8500N
	 24 Beige M1 NCS S 2005-Y50R
LED temperature color	2700 K / 3000 K / 3500 K
Dimming	PUSH DALI / CASAMBI
Installation type	Wall mount / Built-in XS

Materials
Body: Zinc Alloy
Optics: PMMA- Methacrylate
Ceiling rose: Aluminum

Light source 1 x undefined



LED CRI>90 680 lm 94,4
2700 K / 3000 K / 3500 K

Driver Constant Current 400
220-240 V V 50-60 Hz HZ

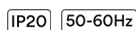
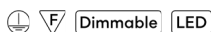

Application Hanging lamps

Packaging 1 Box
0.15 m x 0.3 m x 0.075 m
Gross weight 1.39
Net weight 1.09
Vol. 0.0033

Lighting effect

Accent Spotlight

Narrow: Angles less than 20°. Suitable for generating high contrasts or projections at far distances. Medium: Angles between 20° and 40°. Suitable for generating medium contrasts or projections at medium distances. Wide: Angles greater than 40°. Suitable for generating moderate contrasts or projections at near distances.

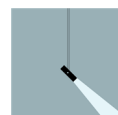

Photometric Data

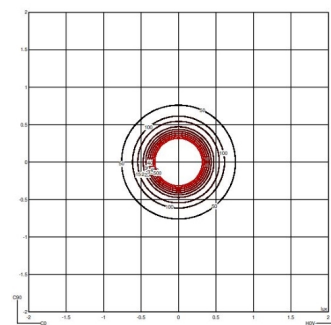
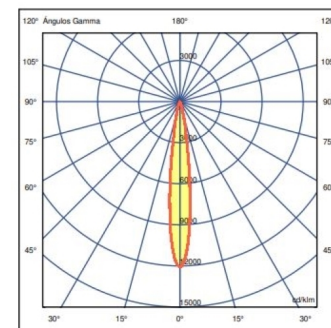

Efficiency	76.753 lm/W
Coordinate System	CG
Total Flux	575.6 lm
Maximum Value	12087.14 cd/klm

All of our products come with a five-year warranty. Check our legal terms at www.vibia.com/warranty

Vibia Lighting, S.L.U.

Office / Oficina
Progrés 4-6. 08850 Gavà. Barcelona, Spain.

International T +34 934 796 971
Spain / Portugal T +34 934 796 970

customer.service@vibia.com
vibia.com